



**CENTRAL ELECTRÓNICA**  
**CENTRALE ELECTRONIQUE**  
**MC 4 SP**



**Manual del utilizador / programador**  
**Notice pour d'utilisateur/programateur**

**ÍNDICE / INDEX**

	<b>PAG.</b>
<b>Español</b> .....	2
<b>Français</b> .....	5

**E**

**1.- DATOS TÉCNICOS**

<b>A</b>	<b>CN1: CONÉXION DE LA ALIMENTACIÓN CENTRAL</b>
1	Azul - Entrada de la Línea de AC230V-(neutro)
2	Castaño - Entrada de la Línea de AC230V (fase)

<b>B</b>	<b>CN2: CONEXIONES DEL MOTOR</b>
3	Negro - Salida del Motor AC230V (SUBIDA)
4	Azul - Salida del Motor AC230V (COMÚN)
5	Castaño - Salida del Motor AC230V (BAJADA)

<b>C</b>	
6	Antena

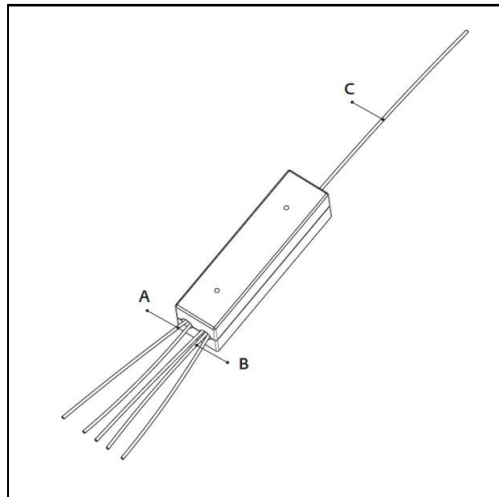

**2.- CARACTERÍSTICAS TÉCNICAS**

<b>Alimentación</b>	AC230V; 50-60Hz
<b>Salida del Motor</b>	AC230V; 350W Máx
<b>Temperatura de funcionamiento</b>	-10°C a 65°C
<b>Frecuencia de Transmisión</b>	433,92 MHz
<b>Nº de Canales</b>	15
<b>Tipo de Código</b>	Rolling Code
<b>Grado de Protección</b>	IP44
<b>Dimensiones</b>	100x26x24mm

### 3.- DESCRIPCIÓN DE MANDOS

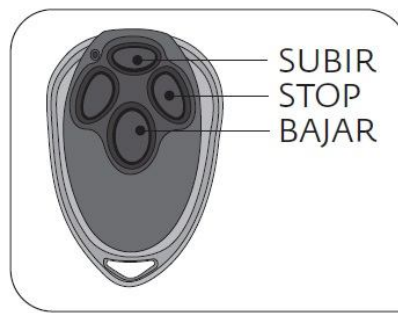
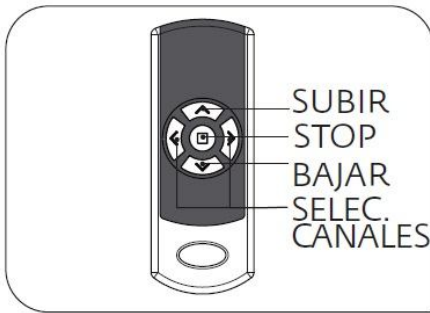

### 4.- PROGRAMACIÓN



La central tiene capacidad para 15 mandos diferentes. Una vez que la memoria este llena , 4 bips rápidos le indicaran que la memoria esta llena.

Siempre que haga una programación nueva, lo tendrá que hacer con la central si conexión eléctrica

#### - Adicionar mando nuevo

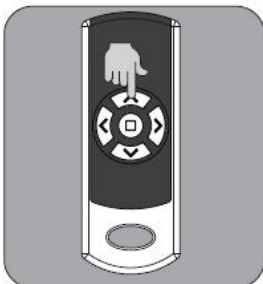

Pulsar el botón subir, y mantener presionado

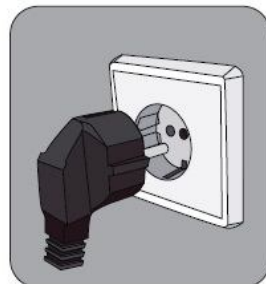

Enchufar la central a la corriente 230v

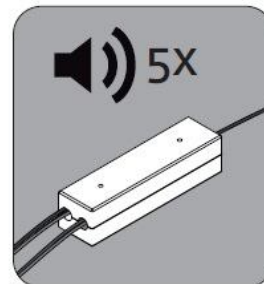

Presione la tecla subir durante 10 segundo en cuanto la central le ira a hacer 5 bips



2 bips rápidos le indicaran que la operación a hecho correctamente

#### - Alterar el sentido del motor



Pulsar el botón bajar, y mantener presionado

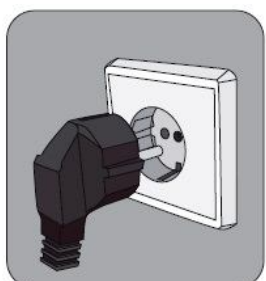

Enchufar la central a la corriente 230v

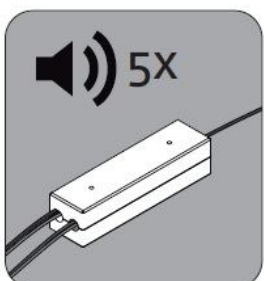

Presione la tecla bajar durante 10 segundo en cuanto la central le ira a hacer 5 bips

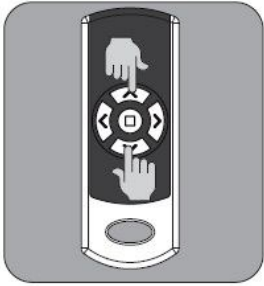

2 bips rápidos le indicaran que la operación a hecho correctamente

**- Desprogramar el mando de la central**

Pulsar el botón bajar y subir al mismo tiempo, y mantener presionado

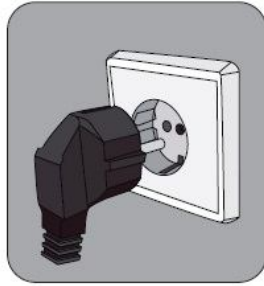

Enchufar la central a la corriente 230v

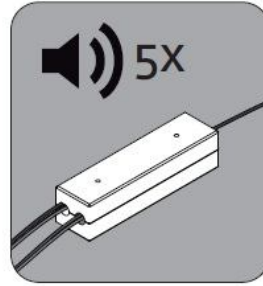

Presione las teclas bajar y subir durante 10 segundos en cuanto la central le ira a hacer 5 bips



2 bips rápidos le indicaran que la operación a hecho correctamente

### 1.- INFORMATIONS TECHNIQUES

A CN1: RACCORDEMENTS DE LA CENTRAL	
1	Bleu - Entrée AC230V (neutre)
2	Marron - Entrée AC230V (phase)
B CN2: RACCORDEMENTS DU MOTEUR	
3	Noir - Sortie du Moteur AC230V (MONTÉE)
4	Bleu - Sortie du Moteur AC230V (COMMUN)
5	Marron - Sortie du Moteur AC230V (DESCENTE)
C	
6	Antenne

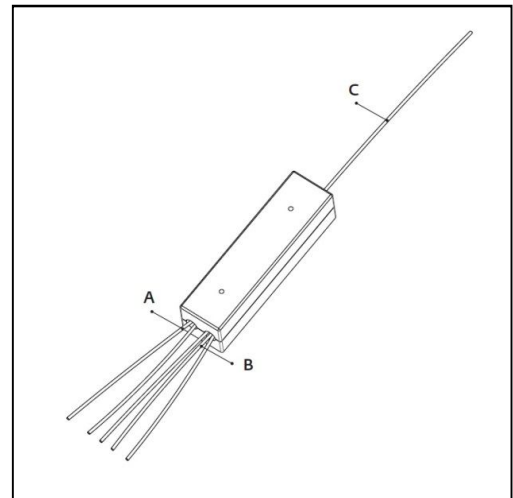

### 2.- CARACTÉRISTIQUES TECHNIQUES

<b>Alimentation</b>	AC230V; 50-60Hz
<b>Sortie du Moteur</b>	AC230V; 350W Máx
<b>Température de fonctionnement</b>	-10°C a 65°C
<b>Fréquence de Transmission</b>	433,92 MHz
<b>N° de Canaux</b>	15
<b>Type de Code</b>	Rolling Code
<b>Niveau de Protection</b>	IP44
<b>Dimensions</b>	100x26x24mm

### 3.- LÉGENDE TÉLÉCOMMANDES

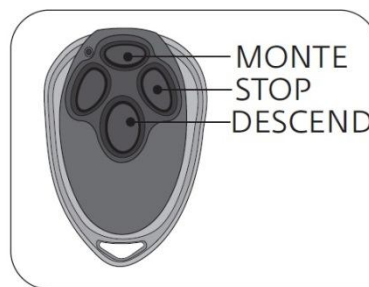

### 4.- PROGRAMMATION



La centrale a une capacité pour enregistrer 15 télécommandes différentes. Une fois la mémoire épuisé 4 bips rapides signaleront que la mémoire est pleine.

Faire tous les programmations suivantes avec la centrale débranchée du courant électrique.

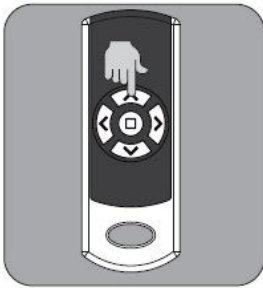
**- Ajouter nouvelle télécommande**

Appuyer et maintenir appuyé le bouton « Monte »

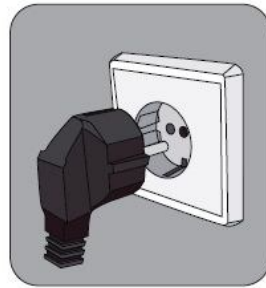

Brancher la centrale à l'alimentation 230V

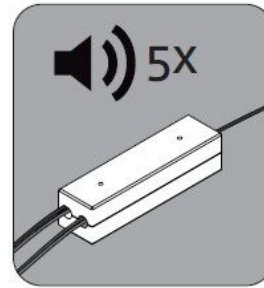

Attendre 10 sec. Pendant que vous appuyez la touche «Monte» et la centrale fera 5 bips espacés.



2 bips rapides confirment que l'opération a été réussie

**- Changer le sens du moteur**

Appuyer et maintenir appuyé o bouton «descend»

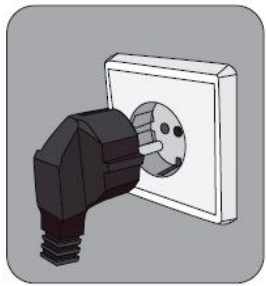

Brancher la centrale à l'alimentation 230V

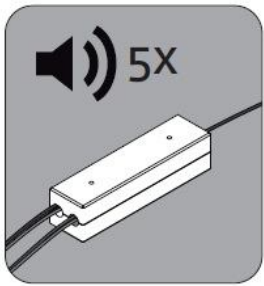

Attendre 10 sec. Pendant que vous appuyez la touche «descend» et la centrale fera 5 bips espacés.

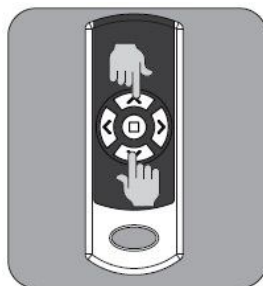

2 bips rapides confirment que l'opération a été réussie

**- Supprimer des télécommandes de la mémoire de la centrale**

Appuyer et maintenir appuyé o bouton «Monte» et «descend» au même temps

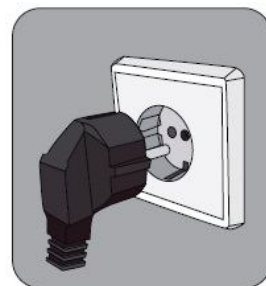

Brancher la centrale à l'alimentation 230V

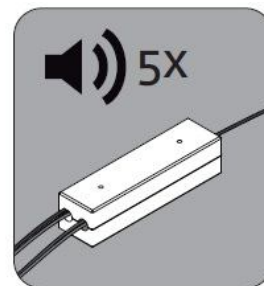

Attendre 10 sec. pendant que vous appuyez la touche «Monte» et «descend» et la centrale fera 5 bips espacés.



2 bips rapides confirment que l'opération a été réussie



**Carballiño, 33, 36645 Valga – Pontevedra (España)**

**Telf: (0034) 986 556 371 / Fax: (0034) 986 557 867**